



Data Logger NetLogCom

Reliable data storage and transferral

- Comfortable and convenient operation with membrane keyboard and function keypad.
- 3,5" TFT-Colour display with graphics of time series and hydrographs. (Graph and list formats).
- Large storage capacity and data security.
- Integrated 4G Modem
- Voice messaging, VoiP (Option).
- Voice messaging and push operation via different networks
- Ethernet-interface.
- Analogue and digital input channels for connection of external sensors.
- Intelligent alarm-management system.
- Compact and aesthetic plastic housing.
- Both network adapters can be used simultaneously (routing).

Description

The **NetLogCom** has been specially developed and tailored to meet the stringent requirements of the waterway and water management administrations, as set out in Annex E of "Water-level legislation". Thanks to the powerful NXP i. MX6 processor, functions and data access on the **NetLogCom** run separately and can thus be processed in parallel. This also affects the processing on all interfaces.

The station manager is equipped with a TFT colour display, keyboard, voice prompter, 4G modem, TCP / IP interface for connecting a DSL router, numerous digital, analogue and serial inputs, a generous 2GB flash memory and much more.

Particularly noteworthy is the integrated alarm management of the station manager in the case of exceeded value limits. Alarms can be sent via voice, SMS, e-mail, FTP, HTTP etc. The user can define how best to set various value limits, alarm channels, alarm groups and up to 32 alarm destinations.

Specific requirements may need tailor-made solutions. For this reason, the **NetLogCom** can be assembled as a modular system, depending on infrastructure and boundary conditions.

Do you need even more analogue or digital inputs for the connection of additional sensors? Is a redundancy concept with different transmission paths (mobile radio, fixed network) required? Should the stored data be transferred to a process control system? With the **NetLogCom**, you will quickly discover the possibilities of an intelligent data management system.

Equipped with all communication protocols and formats commonly used in the water industry, the **NetLogCom** station manager not only impresses with its extensive range of features and its high operational reliability. In short, it is the perfect data collector, equipped with all the usual communication protocols and formats for modern, up-to-date measurement, data acquisition and transmission management 4.0.

The large TFT colour display, the keyboard and function keypads make **NetLogCom** configuration or retrieval of current status information very easy. In addition, time series in the form of hydrographs and lists are also clearly displayed by the station manager. Setting up a password for specific functions protects the **NetLogCom** against unauthorized access.

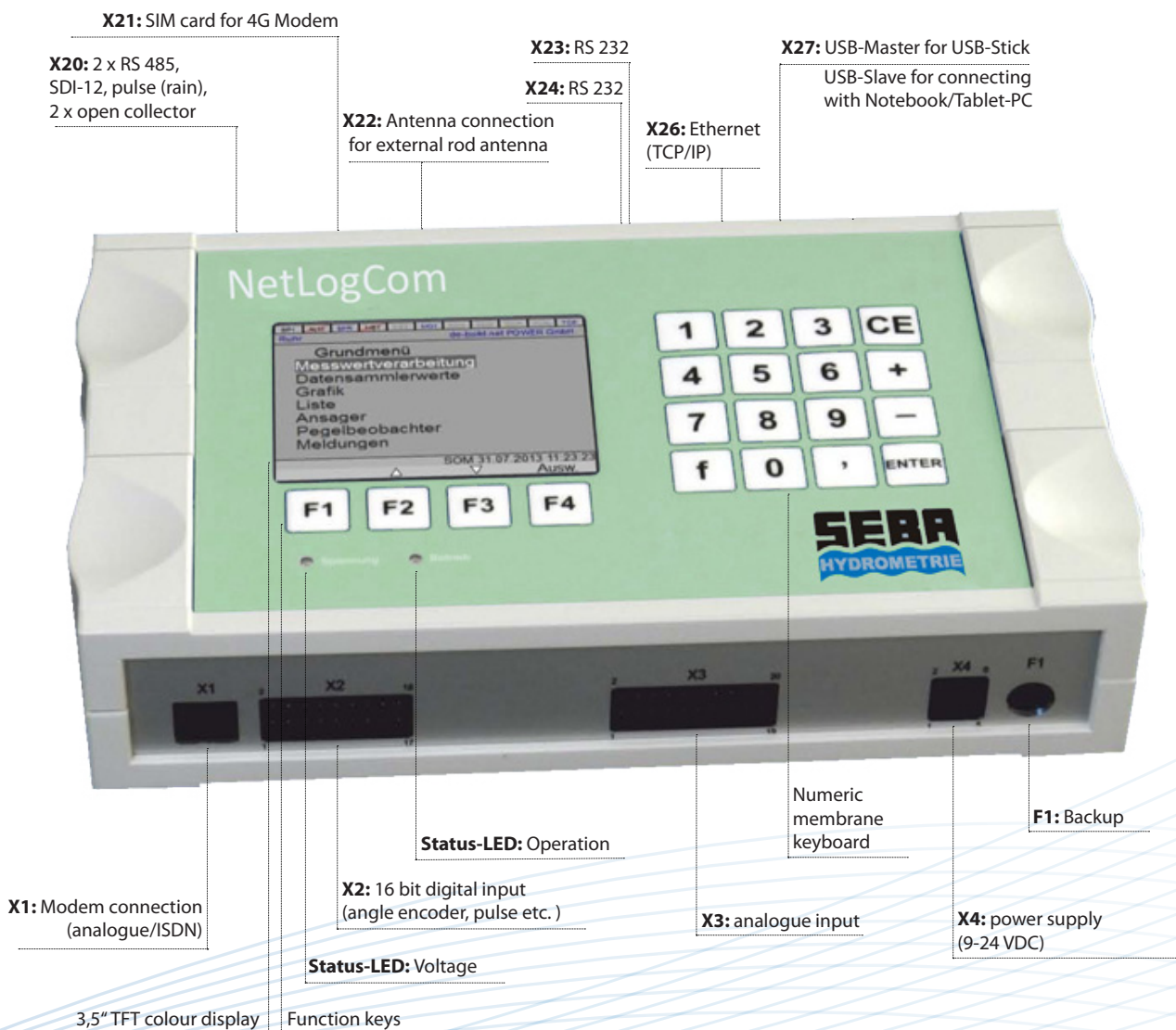

Redundancy concept

For the realisation of a redundancy system in the water industry at HND levels (A-level), there are numerous options:

1) 1 logger, 1 and/or 2 transmission paths, 2 sensors (water level)

Configuration: 1 x NetLogCom via fixed network (TCP / IP), and/or via mobile network (4G modem), 1 x water level sensor (e.g. SEBA PS-Light-2) to RS 485 input, 1 x water level (e.g. SEBAPuls) 4-20 mA analogue input;

Measurement station

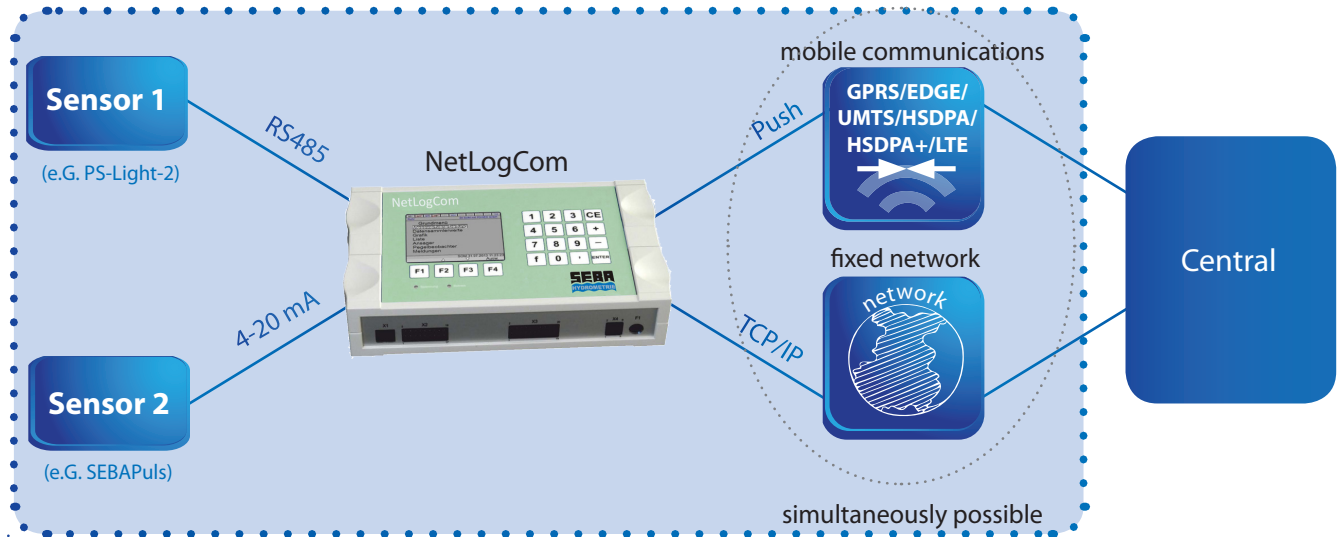

2) 2 Logger, 2 transmission paths, 2 sensors (water level), (physically independent)

Configuration: 1 x NetLogCom via fixed network (TCP / IP), 1 x NetLogCom via mobile network (4G modem), 1 x water level sensor (e.g. SEBA PS-Light-2) to RS 485 input, 1 x water level (e.g. SEBAPuls) 4-20 mA analogue input;

Measurement station

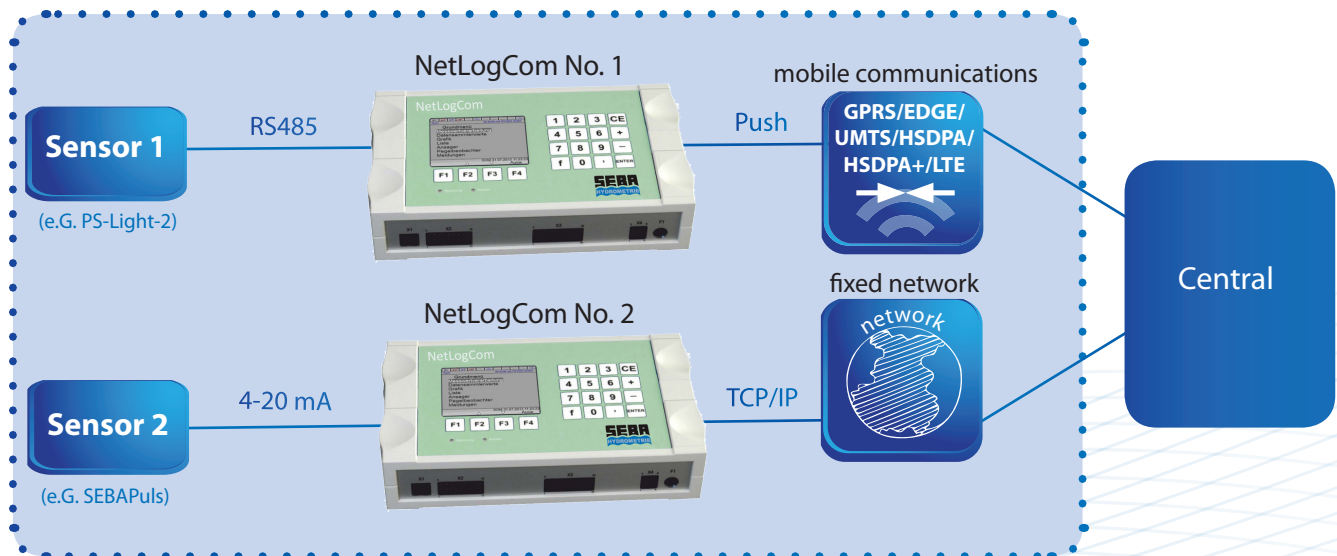

Redundancy concept

3) 2 Logger, 2 transmission paths, 2 sensors (water level), (crossed configuration)

Configuration: 1 x NetLogCom via fixed network (TCP / IP), 1 x NetLogCom via mobile network (4G modem), 1 x water level sensor (e.g. SEBA PS-Light-2) to RS 485 input NetLogCom1 + 2, 1 x Water-level (e.g. SEBAPuls) 4-20 mA-Analogue input to NetLogCom 1 + 2;

Measurement station

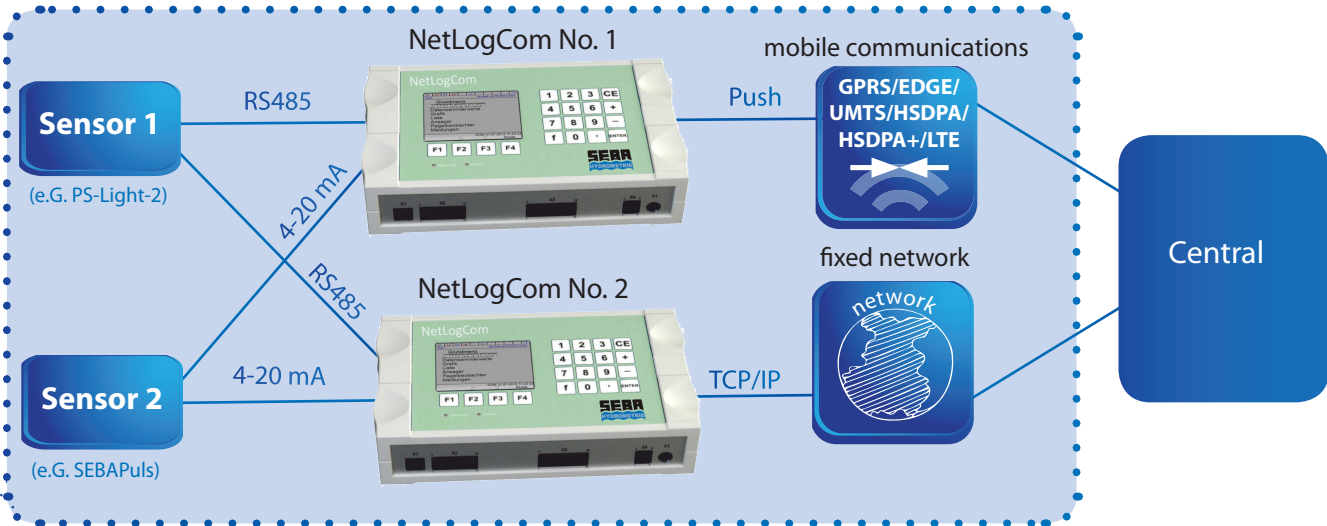

4) 2 Logger, 2 transmission paths, 2 sensors (hydrological, meteorological or agro-meteorological sensors), (with serial data verification)

Configuration: 1 x NetLogCom via fixed network (TCP / IP), 1 x NetLogCom via mobile network (4G modem), 1 x water level sensor (e.g. SEBA PS-Light-2) to RS 485 input, 1 x water level (e.g. SEBAPuls) 4-20 mA analogue input; Serial connection between NetLogCom 1 and NetLogCom 2

Measurement station

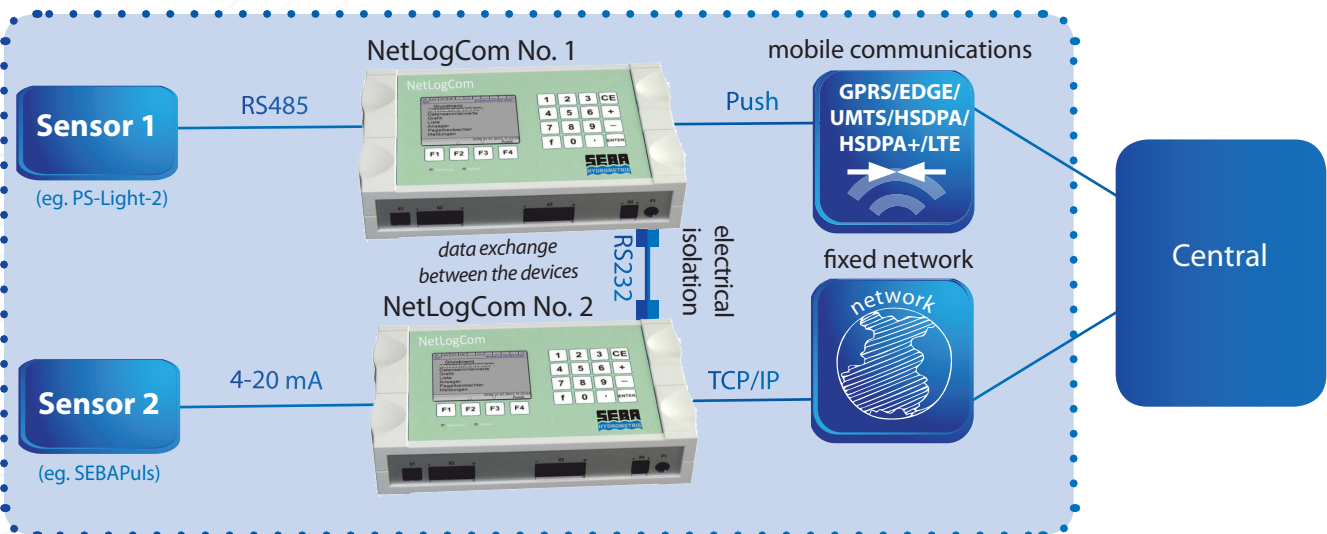

The input channels (W, W1) can be monitored continuously via differential channels in the **NetLogCom**. If the channels drift apart for instance or in the event of an error message (faulty sensor) an instantaneous alarm signal is sent according to the

previously established alarm configuration. This signal can be sent by: SMS, FAX, voice prompts, e-mail). Data can be retrieved via the HTTP server, even if it is password protected.



Additional analogue and digital inputs and outputs:

With the help of external Bus Terminals (WAGO), the **NetLog-Com** can be extended at any time. A bus coupler with Ethernet connection and corresponding input and output terminals are

required for connection. The bus coupler communicates via a TCP / IP connection. The data are transferred to the station manager via the Modbus protocol.

bus coupler

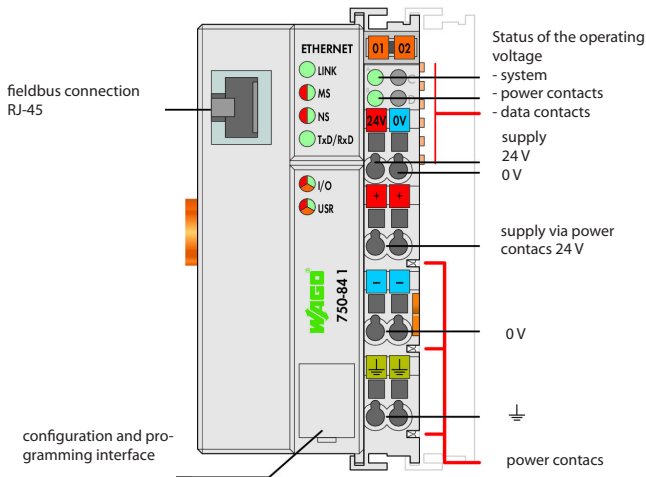

extension clamps

Digital input

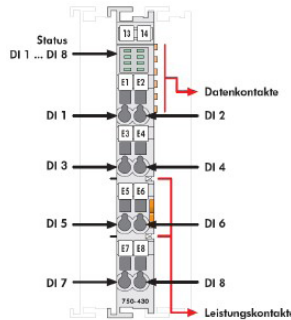

8 x 24VDC

Digital output

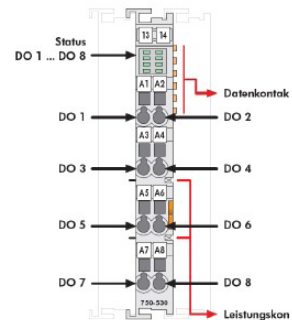

8 x 24VDC

Analogue input

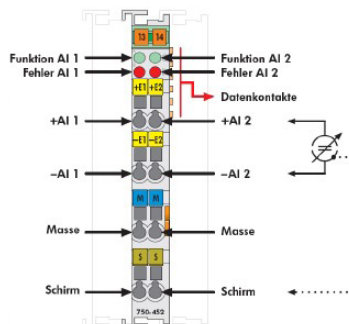

2 x 0 - 20mA

Analogue output

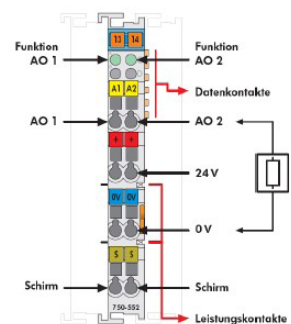

2 x 0 - 20mA

Voice over IP (VoIP)

In addition to the standard integrated voice announcements via 3G modem, there is also the possibility to realise a VoIP connection on-site with appropriate infrastructure (DSL connection). The VoIP module in the **NetLogCom** has its own net-

work interface so that the announcement or error message does not run over the network of the station manager (Intranet). The VoIP module is instead installed in the **NetLogCom** fixed network modem (ISDN, analogue modem).

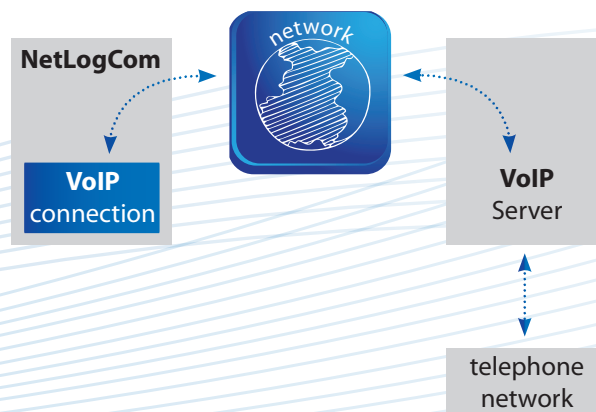

Alarm management

The alarm function in the **NetLogCom** runs as a separate process and checks various conditions, which can then lead to the triggering of an alarm and its forwarding to a specified target. There are numerous parameters which can be entered, for example that of checking a certain value's limit. An "alarm chain" must first of all be configured. In order to do so, the alarm channel is first used to determine which parameters are to be checked. Then, within the alarm group, the destination of the alarm

must be selected, as well as via which transmission mechanism the alarm is to be sent. The central point in the alarm function is that of the alarm groups, of which there are 16. Each has 10 target entries and 4 entries for the selection of target groups. There are 16 additional target groups with 10 target entries, so as to permit a flexible alarm transmission. Alarm function and display messages and data are sent by push.

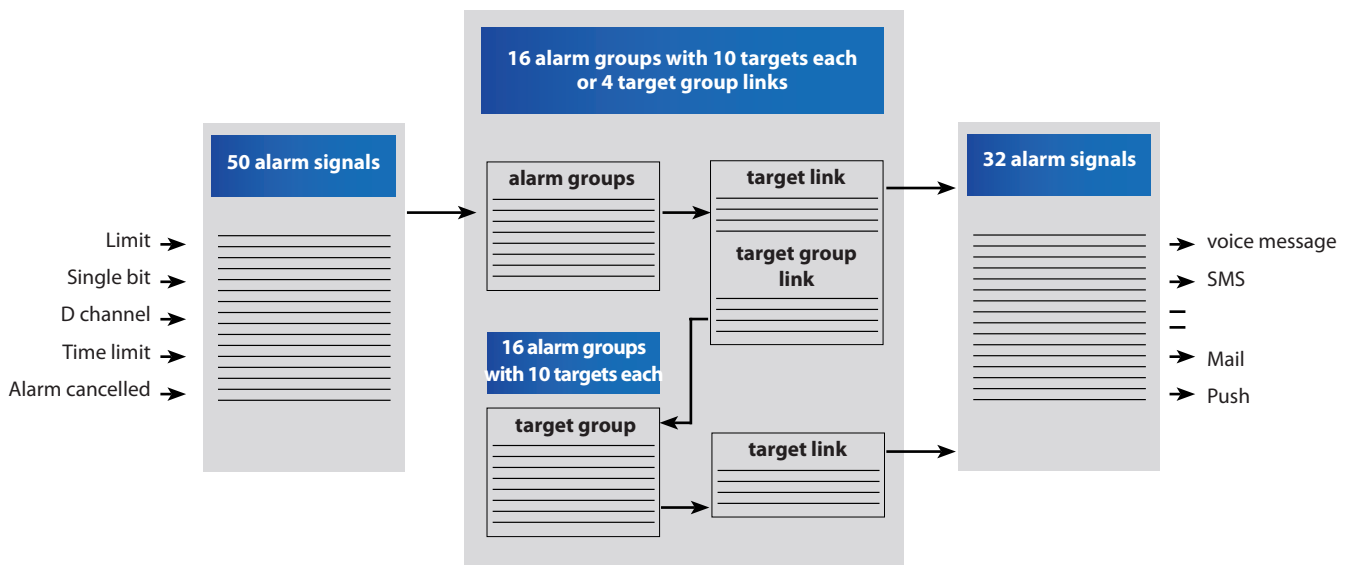

Connecting NetlogCom with process control systems

Siemens S7 function

The S7 function is used to transfer data to a Siemens S7 programmable controller. The first 10 data collector channels and the first 51 limit values that are set up in the NetLogCom are transferred to the S7. During data transmission, NetLogCom describes a data block which is then queried and defined by S7. Both device information and data can be exchanged via the data module.

MODBUS function

Using the MODBUS function, data from MODBUS / TCP enabled devices can be used to acquire measured values or to send values to devices via the network. The devices can be reached via their IP addresses. The NetLogCom has two MODBUS groups, and therefore it is possible to communicate with two separate devices.

Analogue/Digital outputs (optional)

With aid of an external bus coupler, in conjunction with analogue (0/4-20 mA) and/or digital output clamps, NetLogCom can be modularly expanded.

Technical data

Logger:	Controller:	Triceps 4: XScale, 32-Bit-ARM-v5TE-Processor Triceps 7: NXP i. MX6 ARM Cortex A9 RTC-IC-real-time clock
	Storage capacity:	2 GB SD FlashCard for about. 50 Million data measurements
	Storage interval:	from 10 seconds upwards
	Channels:	max. 100
	Measurement routines:	Single value, mid-value, daily minimum-/maximum, Deltamode
	Communications interface:	2 x RS 232, 2 x RS 485, Ethernet (TCP/IP), SDI-12, USB, 3G Modem/ 4G (Option), optionally ISDN-or Analog-Modem or VoIP
	Operation:	RS 232 interface cable, TCP/IP, Membrane Keyboard, Modem
	Input:	digital: 16 Bit (8 x Impulse), BCD, Gray, Binary, Impulse input (Rain) analogue: 5 x 0/4-20 mA (or 3 x 0/4-20 mA, 2 x 0-10 V), 1 x PT100
		Modbus: TCP/IP, RTU Protocols: SEBA SHWP, SEBA-PS-Delta, RDI/Teledyne ChannelMaster PD19, PD0, OTT SLD, Easy Q, Flow2000, MIO, Quantum, level-online
	Outputs:	analogue, digital: Buscontroller via TCP/IP, Modbus: TCP/IP Protocols: RS 232, RS 485, Rotor, GS display, display screen Data transmission to Siemens S7
	Housing:	Material: Plastic ABS Dimensions: 240 x 138 x 55 mm Display: 320 x 240 (3,5") TFT-Colour-Display with graphic display of time series (Hydrograph, List) Numerical keyboard with 4 function keys Protection type: IP 40 Fixing: Wall-mounted, 19" Rack (Optional)
4G Modem:	Supported networks:	GPRS/EDGE/UMTS/HSDPA/HSDPA+/LTE
	Frequencies:	800/900/1800/2100/2600 MHz (Worldwide)
	Antenna:	with magnetic base: 850, 900, 1800, 1900 MHz
	Communications:	Push-Protocols: FTP, SFTP, HTTP, HTTPS Push-Format: zrxp, XML Data collection: DDP, XML (TCP/IP)
	Alarm:	Speech, SMS, E-Mail, Fax
	Current supply:	9-24 VDC
	Operating temperature:	-30 °C ... +70 °C

The right is reserved to change or amend the foregoing technical specification without prior notice

Contact:

SEBA Hydrometrie GmbH & Co. KG • Gewerbestraße 61 A • 87600 Kaufbeuren • Germany
Telefon: +49 (0) 8341 96 48 - 0 • E-Mail: info@seba.de • Web: www.seba.de